FIRE PUMPS



 **Fairbanks Morse**

 **Pentair** Pump Group



HORIZONTAL SPLIT CASE FIRE PUMP SYSTEM DIESEL ENGINE DRIVEN

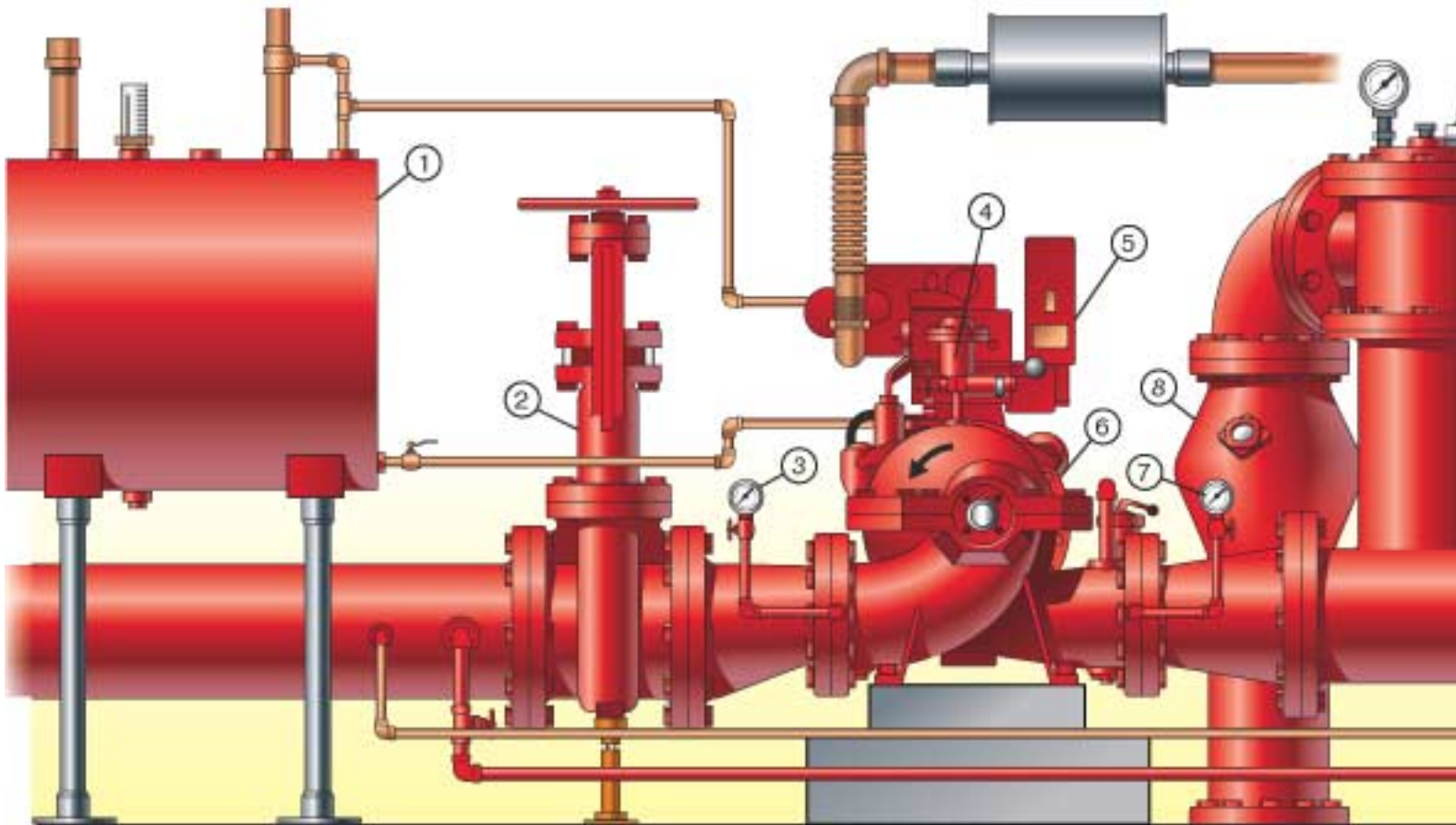

- | | | |
|------------------------------------|---|--|
| 1. Fuel Tank, Diesel Engine | 7. Discharge Pressure Gauge | 13. Jockey Pump Controller |
| 2. Isolation Gate Valve (suction) | 8. Enclosed Waste Cone with Sight Glasses | 14. Jockey Pump |
| 3. Compound Suction Gauge | 9. Main Relief Valve | 15. Isolation Valves |
| 4. Automatic Air Release Valve | 10. Low Suction Pressure Shutoff Valve | 16. Ball Drip Valve |
| 5. Diesel Engine Drive | 11. Fire Pump Controller | 17. Test Valve Manifold with Hose Valves,
Caps & Chains |
| 6. Horizontal Split Case Fire Pump | 12. System Check Valve | |

Pump: Horizontal split case, double-suction, UL Listed, FM Approved, mounted on a common base with and flexibly coupled to a diesel engine. Pump sized for rated capacity and head. Also must be capable of producing 150% rated flow at not less than 65% rated head and not to exceed 140% rated head at a shutoff or no-flow condition.

Diesel Engine: UL Listed or FM Approved diesel engine adequately sized so as to not overload at any point on the pump hydraulic curve. Consideration must be given and de-rates applied based on job site elevation and ambient temperature. Engines must be specifically designed for fire protection service.

Coupling: Flexible type, sized to transmit the horsepower requirements of the pump. Coupling shall be furnished with an OSHA-design coupling guard.

Base: Fabricated steel design base capable of adequately supporting the weight of the pump and driver. After pump has been fully piped and accurately aligned with the engine, the base should be fully grouted into place.

Controller: Diesel engine controller starts the engine automatically on a loss of system pressure. System pressure is monitored via a sensing line from the system side of the check valve. Controller can also be manually started. Controllers are UL Listed and FM Approved specifically for fire pump service.

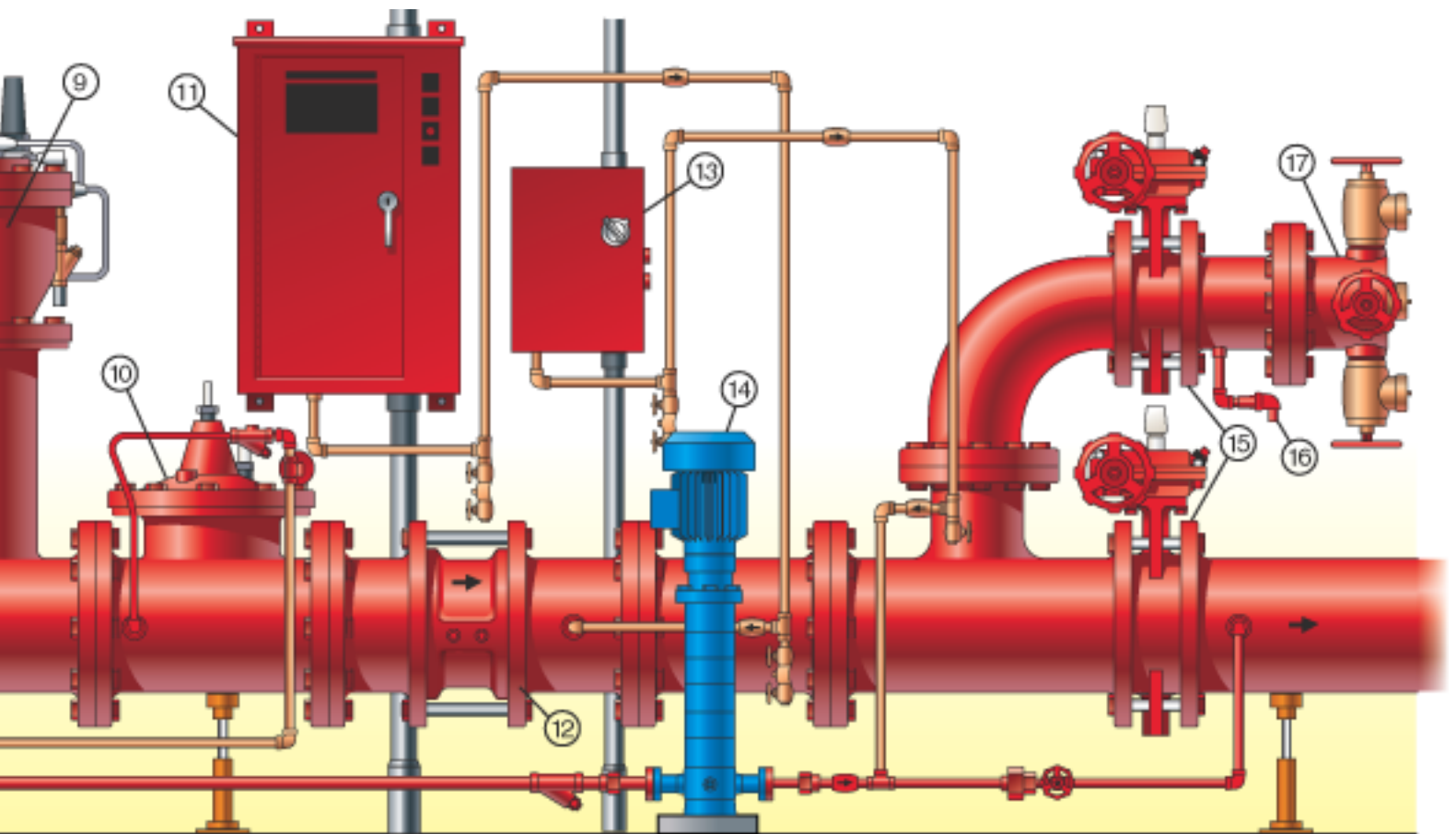

Standard Pump Accessories: Accessories furnished with the fire pump system include: suction and discharge gauges and automatic air release valve. Other accessories commonly furnished as part of the fire pump package include: hose valve manifold with hose valves, caps and chains, flowmeter, main relief valve and enclosed waste cone, ball drip valve, eccentric suction reducer, concentric discharge increaser.

Standard Engine Accessories: Accessories furnished with the diesel engine include: engine starting batteries, battery rack, battery cables, engine exhaust flexible connector and silencer.

Jockey Pump: Jockey pump keeps pressure in the system to prevent the main fire pump from operating to maintain system pressure. Jockey pumps are generally a few gallons per minute sized to overcome small system leaks and typically sized for 10 PSI greater than the rated pressure of the main fire pump. Jockey pumps are not required to be UL Listed or FM Approved.

Jockey Pump Controller: Starts the jockey pump across the line by sensing the system pressure via a sensing line from the system side of the check valve. This sensing line must be independent from the main fire pump controller sensing line. Controller is sized per the jockey pump motor horsepower and voltage. Jockey pump controllers are UL Listed specifically for this service.

HORIZONTAL SPLIT CASE FIRE PUMP SYSTEM ELECTRIC MOTOR DRIVEN

1. Isolation Gate Valve (suction)
2. Compound Suction Gauge
3. Horizontal Split Case Fire Pump, Electric Motor Driven
4. Automatic Air Release Valve
5. Casing Relief Valve
6. Discharge Pressure Gauge
7. Low Suction Pressure Shutoff Valve
8. Fire Pump Controller
9. System Check Valve
10. Jockey Pump Controller
11. Jockey Pump
12. Isolation Valves
13. Ball Drip Valve
14. Test Valve Manifold with Hose Valves, Caps & Chains

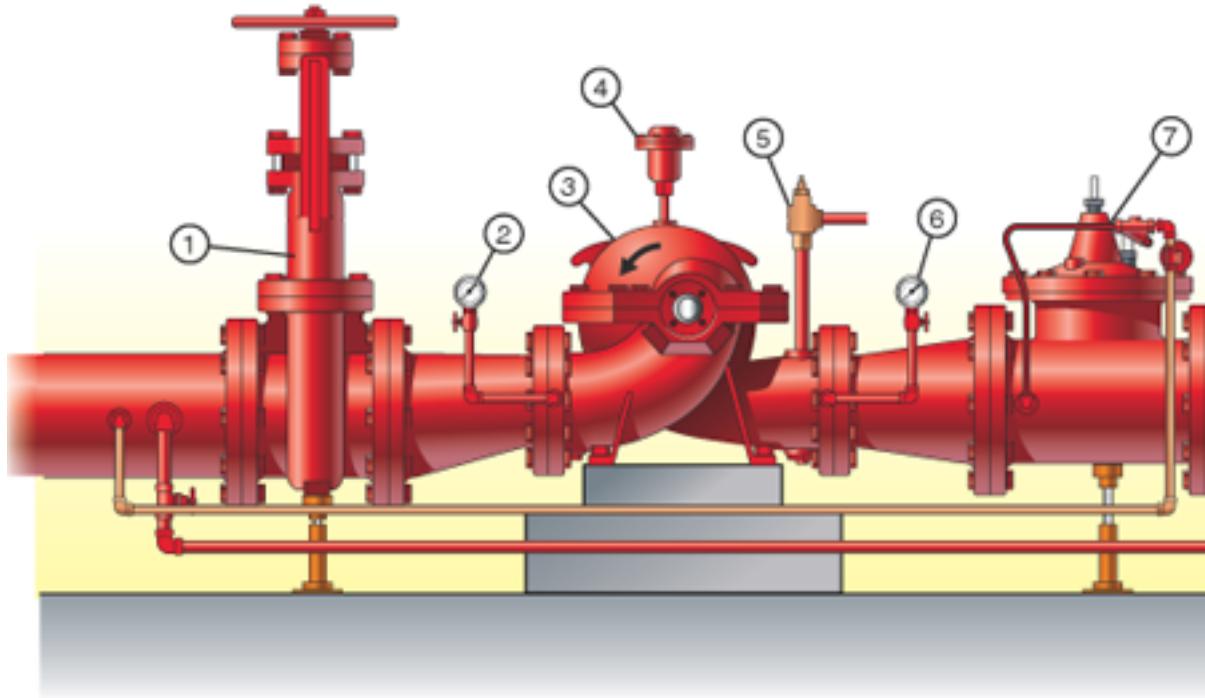

Pump: Horizontal split case, double-suction, UL Listed, FM Approved, mounted on a common base with and flexibly coupled to an electric motor. Pump sized for rated capacity and head. Also must be capable of producing 150% rated flow at not less than 65% rated head and not to exceed 140% rated head at a shutoff or no-flow condition.

Electric Motor: UL Listed or FM Approved motor sized so as to not overload at any point on the pump hydraulic curve as per NFPA #20. Motors are open-drip proof type with a 1.15 service factor wound for the correct voltage. Motor to be compatible with the type of controller (i.e., starting characteristics).

Coupling: Flexible type, sized to transmit the horsepower requirements of the pump. Coupling shall be furnished with an OSHA-design coupling guard.

Base: Fabricated steel design base capable of adequately supporting the weight of the pump and driver. After pump has been fully piped and accurately aligned with the motor, the base should be fully grouted into place.

Controller: Electric motor controller starts the motor automatically on a loss of system pressure. System pressure is monitored via a sensing line from the system side of the check valve. Controller can also be manually started. The type of motor starting, and therefore the type of controller, varies depending upon the specifics of

the application. Common types of controllers include: across-the-line, primary resistor, part-winding, wye-delta, auto-transformer, and soft start. Controllers are UL Listed and FM Approved specifically for fire pump service.

Standard Accessories: Accessories furnished with the fire pump system include: suction and discharge gauges, casing relief valve and automatic air release valve. Other accessories commonly furnished as part of the fire pump package include: hose valve manifold with hose valves, caps and chains, flowmeter, main relief valve and enclosed waste cone, ball drip valve, eccentric suction reducer, concentric discharge increaser.

Jockey Pump: Jockey pump keeps pressure in the system to prevent the main fire pump from operating to maintain system pressure. Jockey pumps are generally a few gallons per minute sized to overcome small system leaks and typically sized for 10 PSI greater than the rated pressure of the main fire pump. Jockey pumps are not required to be UL Listed or FM Approved.

Jockey Pump Controller: Starts the jockey pump across the line by sensing the system pressure via a sensing line from the system side of the check valve. This sensing line must be independent from the main fire pump controller sensing line. Controller is sized per the jockey pump motor horsepower and voltage. Jockey pump controllers are UL Listed specifically for this service.

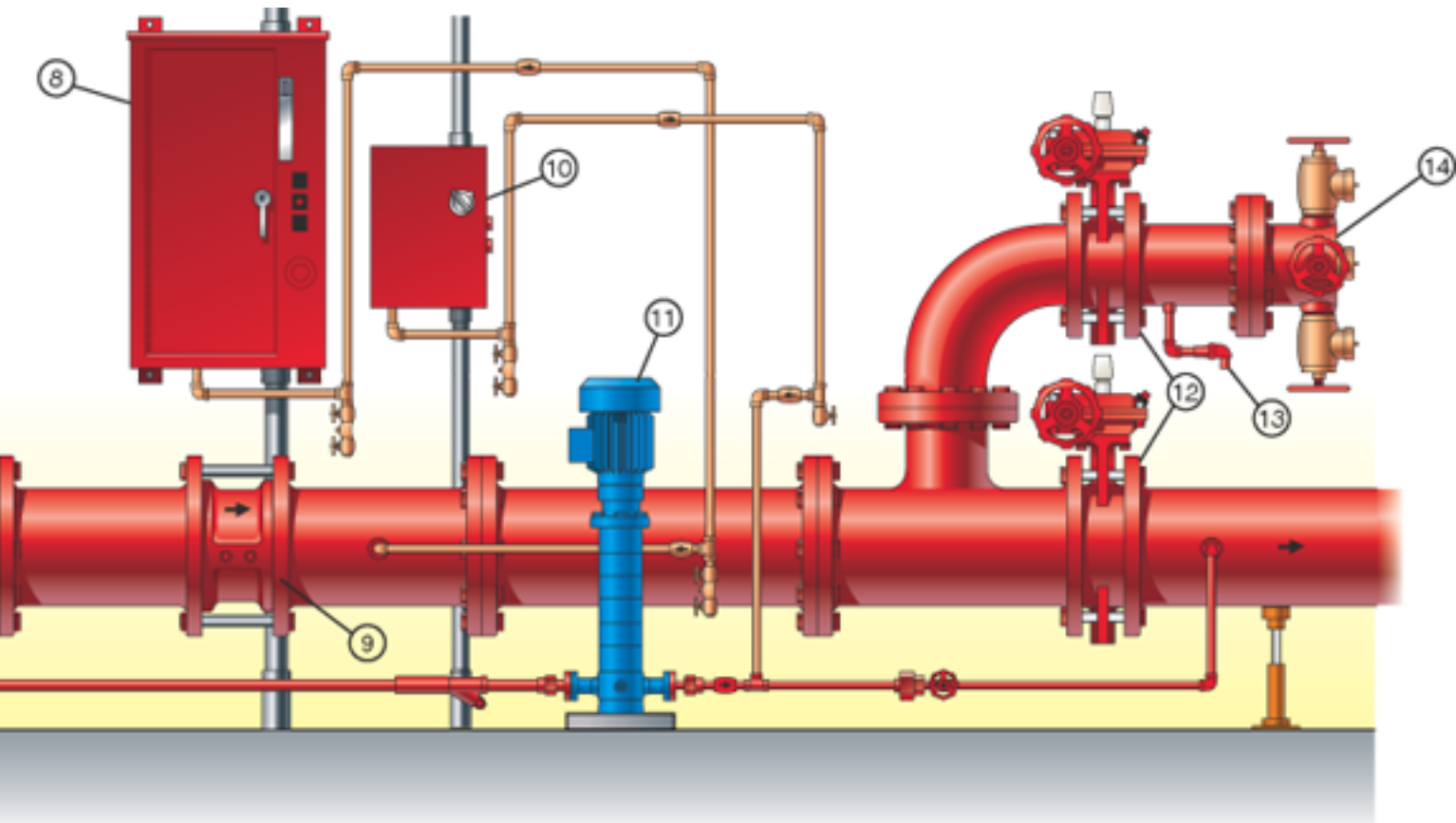

APPROVED CONTROLLER STARTING METHODS

TYPE STARTING	CHARACTERISTICS	ADVANTAGES	RESTRAINTS	STARTING CURRENT (% MOTOR FULL LOAD STARTING CURRENT)	STARTING TORQUE (% LOCKED ROTOR TORQUE)	TYPE TRANSITION
Across-the-line	Connects motor directly to power source. Full voltage applied to motor when controller is actuated.	<ul style="list-style-type: none"> * Least expensive * Highest starting torque * Low maintenance * Standard motor used 	<ul style="list-style-type: none"> * High inrush current 	600%	100%	Not applicable
Primary Resistance Reduced Voltage	When controller is actuated, a resistance is connected to each phase. Resistors are by-passed after a time delay and motor then runs at full voltage.	<ul style="list-style-type: none"> * Smooth starting * Low shock to motor * Standard motor used 	<ul style="list-style-type: none"> * High power loss through resistors * Must dissipate heat * Low torque per ampere input * Medium relative cost * Not recommended for transfer switch applications 	300%	25%	Closed
Part Winding	Motor starts on one winding. After a time delay, second winding is connected in parallel to the line.	<ul style="list-style-type: none"> * Low relative cost * Low starting torque * Low maintenance 	<ul style="list-style-type: none"> * Not recommended for frequent starting * Low starting torque * Special motor required 	390%	42%	Closed
Wye-Delta Open-Transition	On controller activation, motor windings wye-connected for starting. After a time delay, automatically converts to delta connection for running, applying full voltage to motor windings. Most often used with transfer switch/emergency generator applications.	<ul style="list-style-type: none"> * Moderate to low relative cost * Low motor stress * Low starting current 	<ul style="list-style-type: none"> * Medium starting torque * Special motor required for 200V * Power line transients * Can affect other equipment sharing same power source. 	200%	33%	Open
Wye-Delta Closed-Transition	Same sequence as Open Transition. Connected to resistors in each phase during transition from wye to delta.	<ul style="list-style-type: none"> * Moderate to high relative cost * Low motor stress * Low starting current * No line transients 	<ul style="list-style-type: none"> * Medium starting torque * Special motor may be required for 200V 	200%	33%	Closed
Auto Transformer Reduced Voltage w/50% tap w/65% tap w/80% tap	Starters supply reduced voltage starting at motor terminals through use of tapped, 3-phase autotransformer. A timing relay causes transfer of motor from reduced voltage start to line voltage operation without disconnecting motor from power source.	<ul style="list-style-type: none"> * Good for heavy starting loads * Highest starting torque * Standard motor used * Low starting current * Starting torque adjustable 	<ul style="list-style-type: none"> * High relative cost 	150% 252% 384%	25% 42% 64%	Closed
Soft Start/Stop	Reduces inrush current to motor with adjustable ramp time. Stop sequence reduces possibility of surges occurring in the system.	<ul style="list-style-type: none"> * Low inrush current * Adjustable ramp time * Reduces system surges * Standard motor used 	<ul style="list-style-type: none"> * High relative cost 	Adjustable 50% - 500%	Varies	Closed

Long established as a leading fire pump manufacturer, Fairbanks Morse Pump offers a broad range of horizontal split case, vertical in-line and vertical turbine designs over a wide range of rated capacities and pressures...pumps for every fire pump application. Split case and vertical turbine pumps have the option of being driven via either an electric motor or diesel engine, and are furnished as a complete package with controller, jockey pump and its controller, as well as standard fire pump system accessories.

Units are Underwriters Laboratories Listed and Factory Mutual Approved specifically for fire pump service continually meeting their stringent inspection, testing and record-keeping standards. Split case rated capacities range from 250 GPM through 5000 GPM, vertical in-line rated capacities range from 50 GPM through 750 GPM, and vertical turbine fire pumps cover 250 GPM through 4500 GPM, all with a wide range of rated pressures.

The Fairbanks Morse Pump sales family includes highly qualified distributors and representatives well versed in fire pump systems, who provide prompt and accurate quotations, submittals and acceptance testing as required. These sales professionals stand ready to address and meet your fire pump needs, and are backed by many years of factory knowledge and experience.

HORIZONTAL SPLIT CASE

RATED CAPACITY	RATED HEAD
250 GPM	40 – 167 PSI
500 GPM	40 – 278 PSI
750 GPM	40 – 266 PSI
1000 GPM	40 – 244 PSI
1250 GPM	43 – 236 PSI
1500 GPM	40 – 228 PSI
2000 GPM	53 – 210 PSI
2500 GPM	50 – 213 PSI
3000 GPM	60 – 165 PSI
3500 GPM	94 – 151 PSI
4000 GPM	94 – 223 PSI
4500 GPM	90 – 223 PSI
5000 GPM	88 – 221 PSI

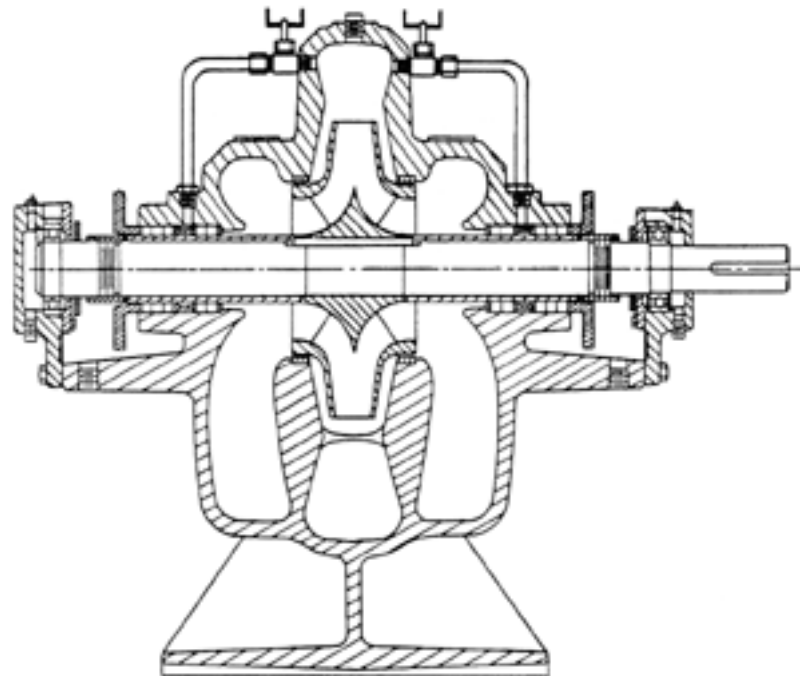

Pump Features:

- ***Bronze impeller keyed to shaft***
- ***Horizontal split case, cast iron***
- ***Clockwise or counterclockwise rotation (electric only)***
- ***Casing wear rings***
- ***Renewable shaft sleeves***
- ***Grease lubricated long life bearings***
- ***Packed stuffing box***

VERTICAL IN-LINE

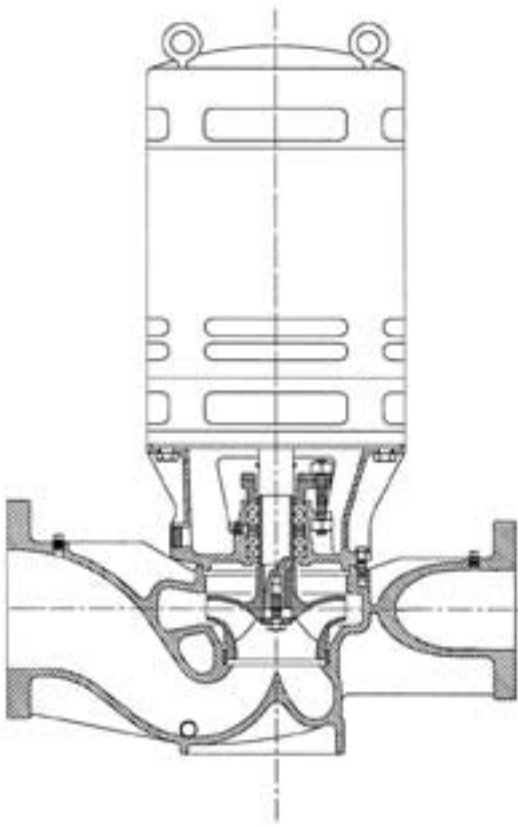

RATED CAPACITY	RATED HEAD
50 GPM	60 – 155 PSI
75 GPM	90 – 135 PSI
100 GPM	40 – 150 PSI
150 GPM	41 – 160 PSI
200 GPM	40 – 160 PSI
250 GPM	40 – 138 PSI
300 GPM	42 – 140 PSI
400 GPM	50 – 205 PSI
450 GPM	49 – 205 PSI
500 GPM	55 – 200 PSI
750 GPM	54 – 143 PSI

Pump Features:

- ***Bronze impeller keyed to shaft***
- ***One-piece, in-line casting***
- ***Clockwise rotation***
- ***Casing wear ring***
- ***Renewable shaft sleeve***
- ***Integral vertical drip-proof motor***
- ***Packed stuffing box***

VERTICAL TURBINE

RATED CAPACITY	RATED HEAD
250 GPM	PSI
500 GPM	100 – 370 PSI
750 GPM	99 – 361 PSI
1000 GPM	96 – 316 PSI
1500 GPM	98 – 320 PSI
2000 GPM	98 – 198 PSI
2500 GPM	100 – 187 PSI
3000 GPM	100 – 189 PSI
3500 GPM	101 – 180 PSI
4000 GPM	120 – 189 PSI
4500 GPM	120 – 181 PSI

Pump Features:

- ***Bronze impellers***
- ***Cast iron bowl (multi-stage)***
- ***Stainless steel bowl shaft***
- ***Carbon steel open lineshaft***
- ***Steel column pipe***
- ***Cast iron or fabricated steel discharge heads***
- ***Brass suction strainer***
- ***Packed stuffing box***

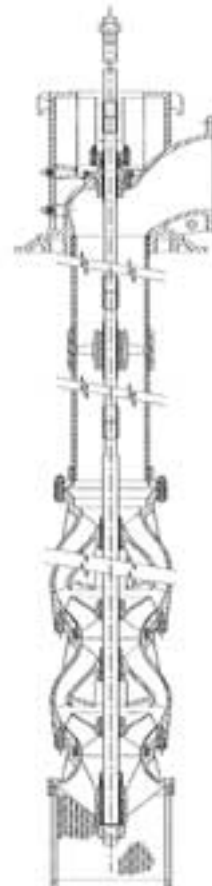

PACKAGED FIRE PUMP SYSTEMS

When the application calls for a completely packaged fire pump system, Fairbanks Morse Pump has the capability to meet these requirements. Systems include the pump, driver, controller, jockey pump and jockey pump controller all mounted on a common base. Controller is pre-wired to the driver, sensing lines are pre-piped from the controllers to the system side of the check valve, and suction and discharge piping is piped to the edge of the common base. Isolation valves, check valve, and test header piping (and/or flowmeter piping) can be supplied as required. For diesel engine driven units, the package would also include the mounting of the fuel tank, piping of fuel lines to the engine and connection of batteries to the engine.

Should your requirements include the packaged fire pump system to include an enclosure, Fairbanks Morse Pump can provide the protective structure to house the system. Packaged systems can be designed for use with horizontal split case, vertical turbine or vertical in-line pump designs.



- Your Authorized Local Distributor -

 **Fairbanks Morse**

 **Pentair Pump Group**

3601 Fairbanks Avenue
P.O. Box 6999
Kansas City, KS 66106-0999
Phone 913/371-5000
Fax 913/748-4025